

MWTT02

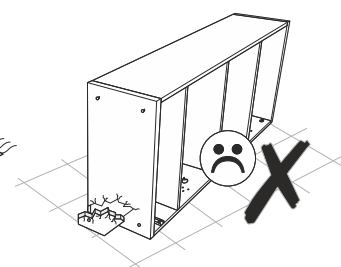

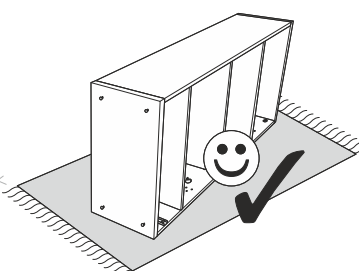

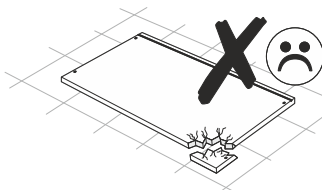

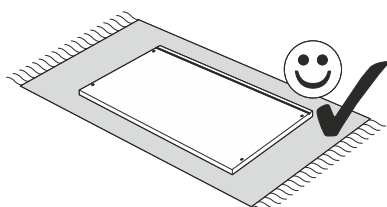
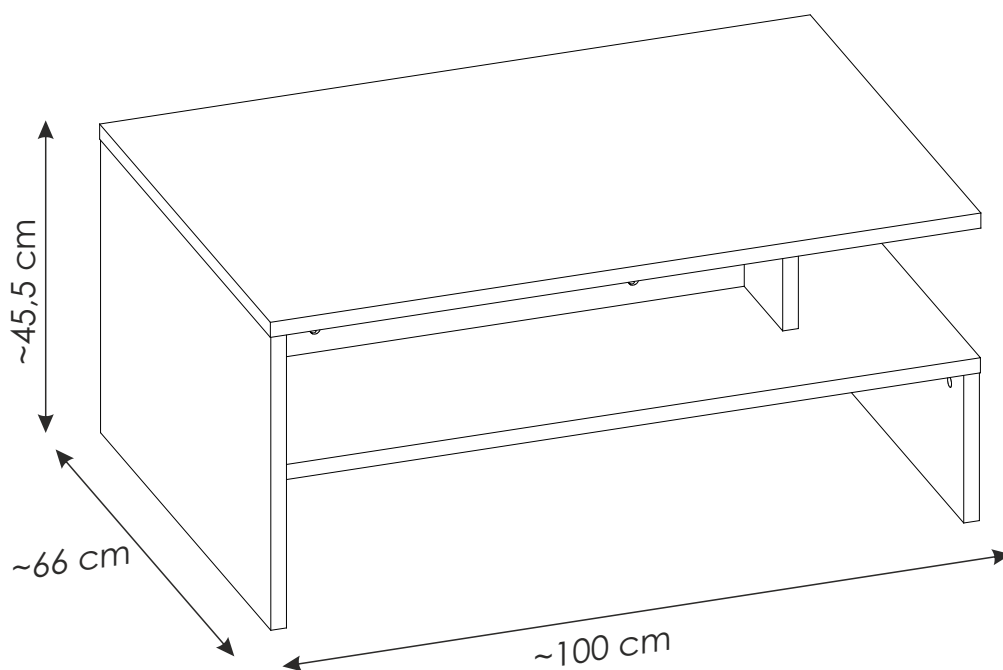
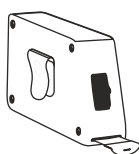
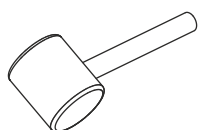
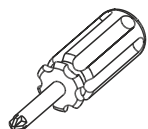
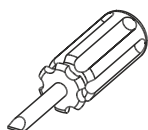
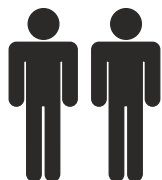
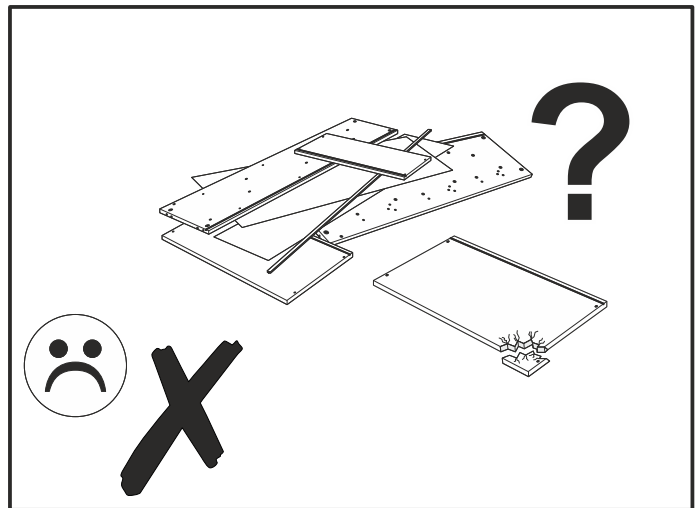
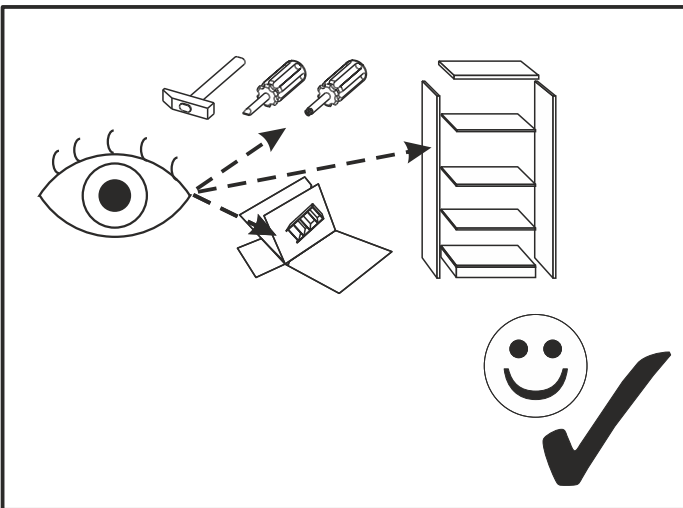
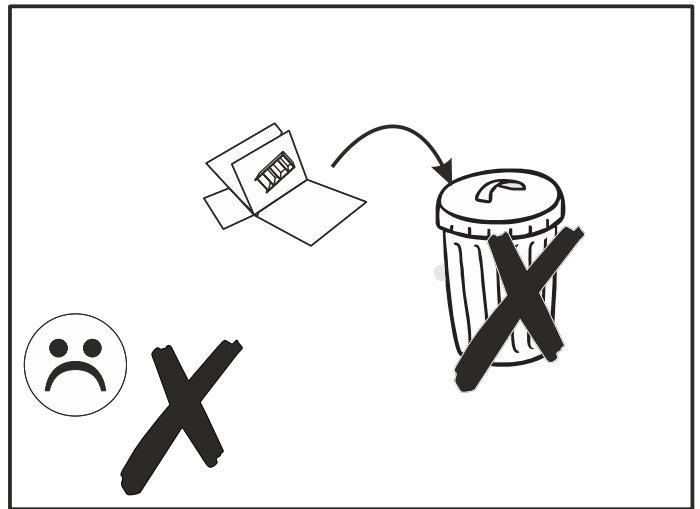
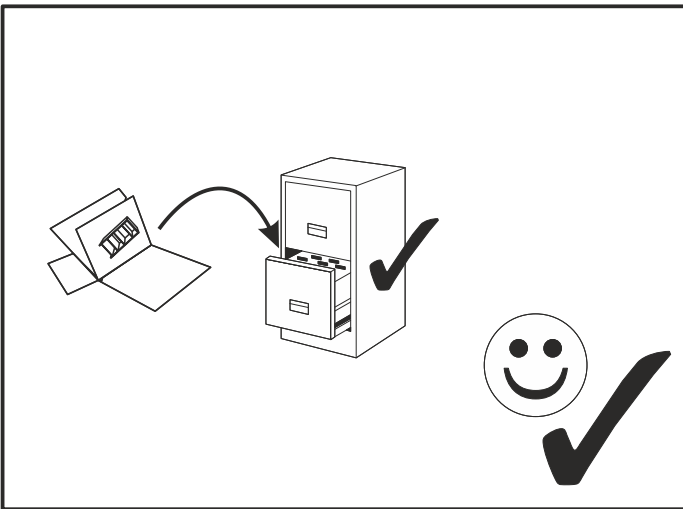
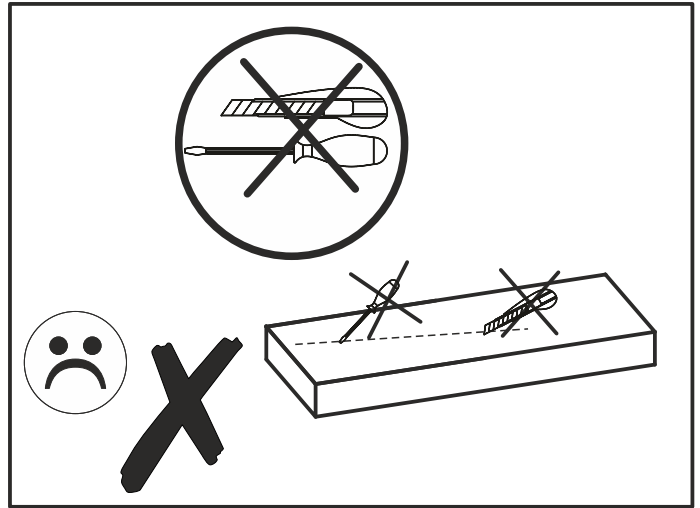
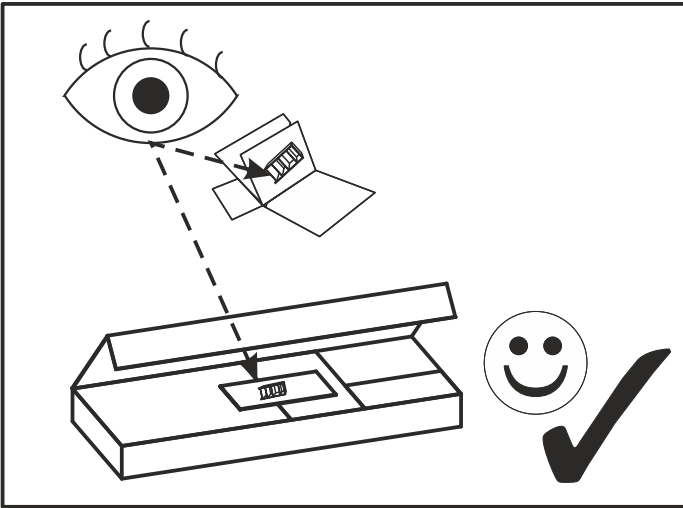

50 min

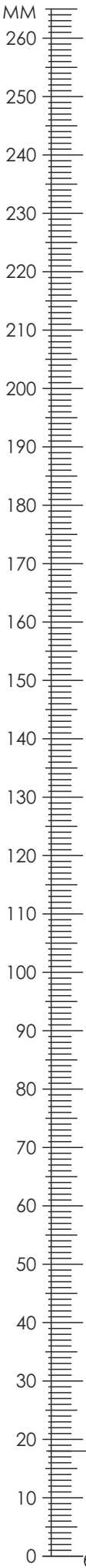



MWTT02

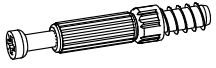

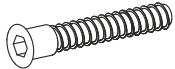
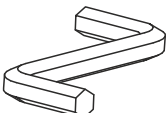
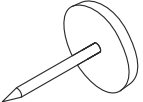
A1 8 x 35 mm x28 	E0 Ø16 x24 	E1 15 x 12 mm x24 
F1 6 x 34 mm x24 	G0 x2 	G1 7 x 50 mm x2 
M x1 	O2 x6 	

MWTT02

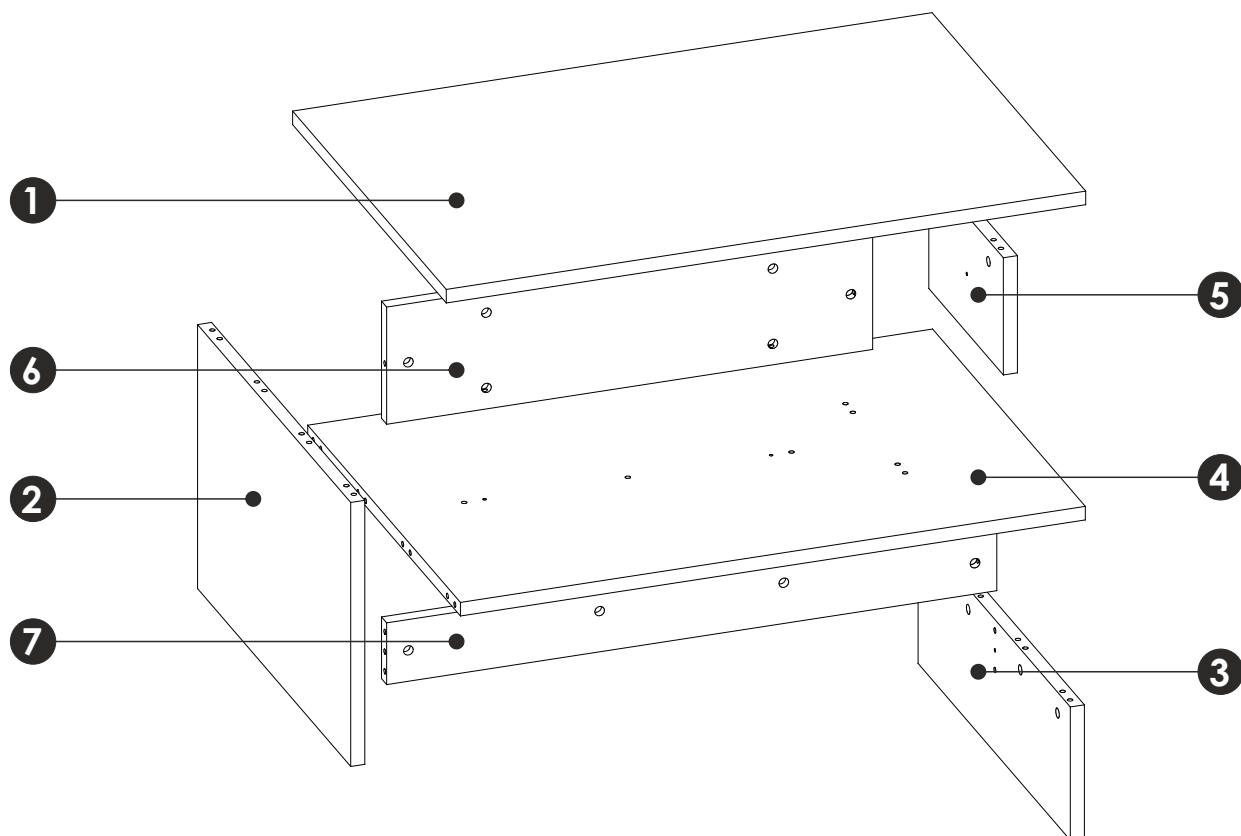
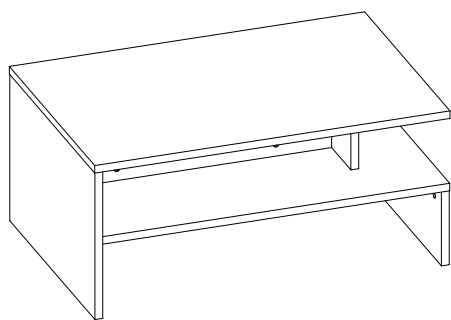

1	660	1000	22	x1	1/1
2	658	428	22	x1	1/1
3	654	216	22	x1	1/1
4	977	656	22	x1	1/1
5	320	190	22	x1	1/1
6	760	190	22	x1	1/1
7	954	100	22	x1	1/1

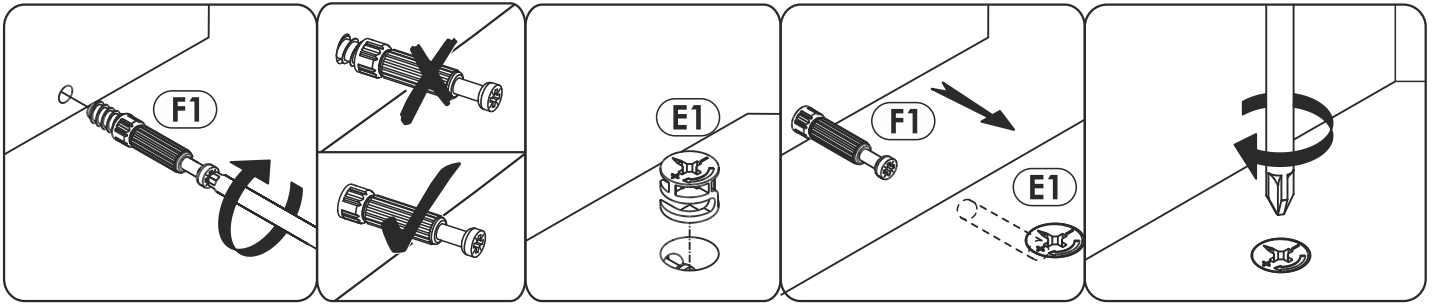

1 ▶

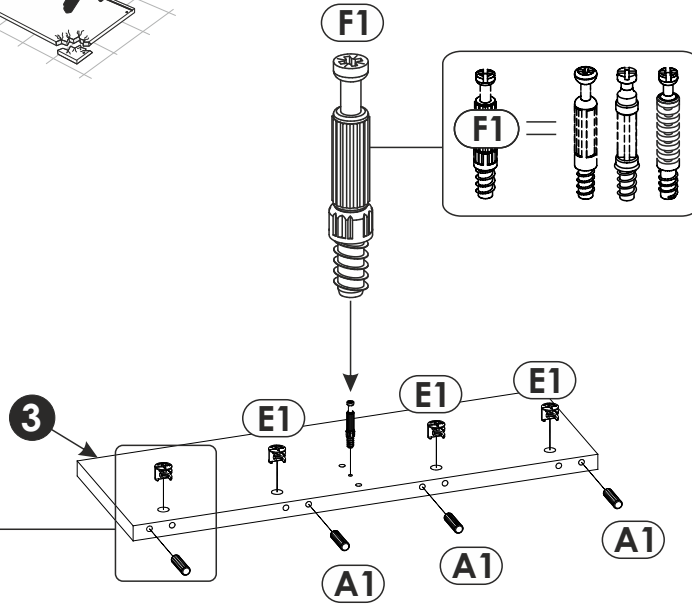
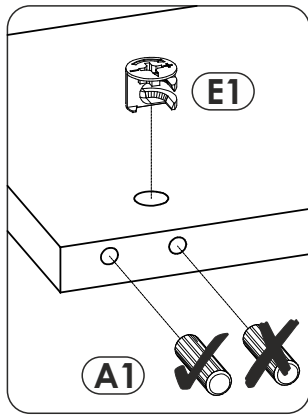
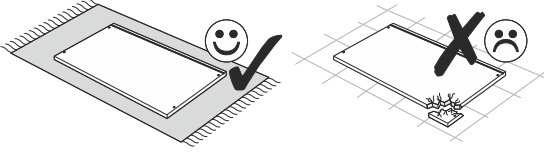

2 ▶

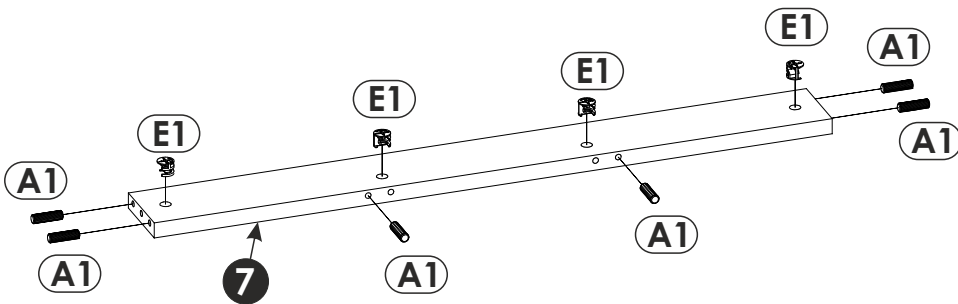
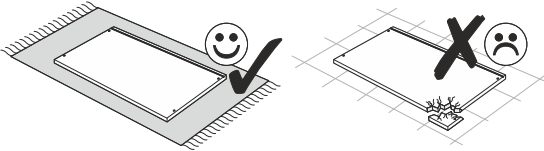

3 ▶

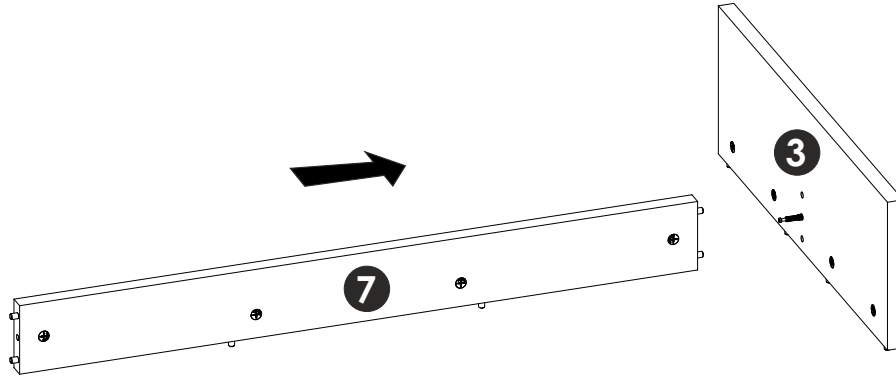
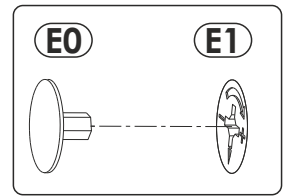
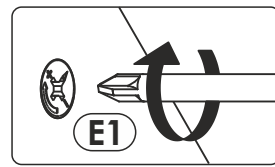
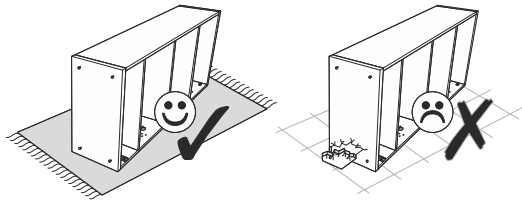

4 ▶

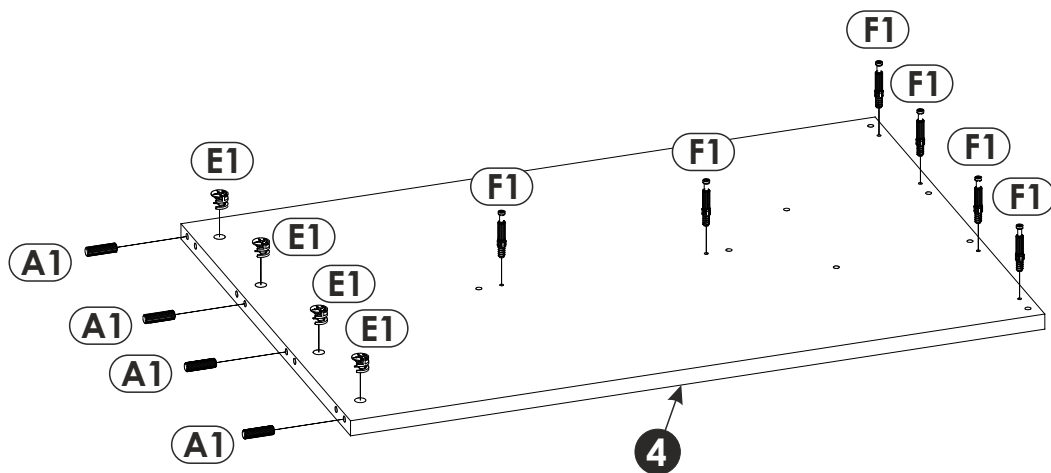
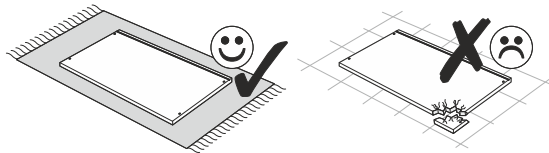

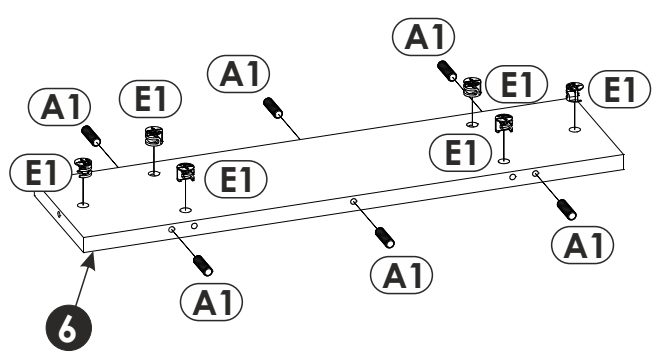
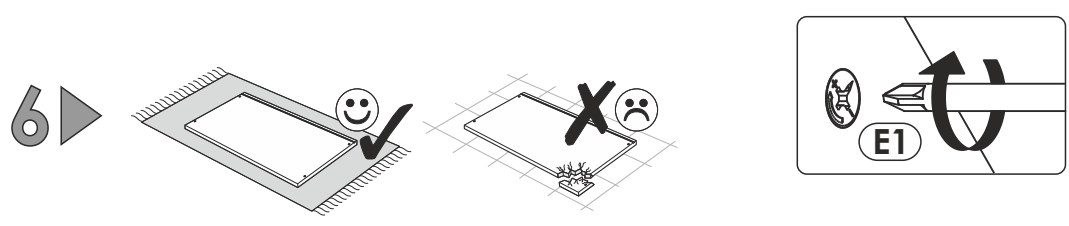
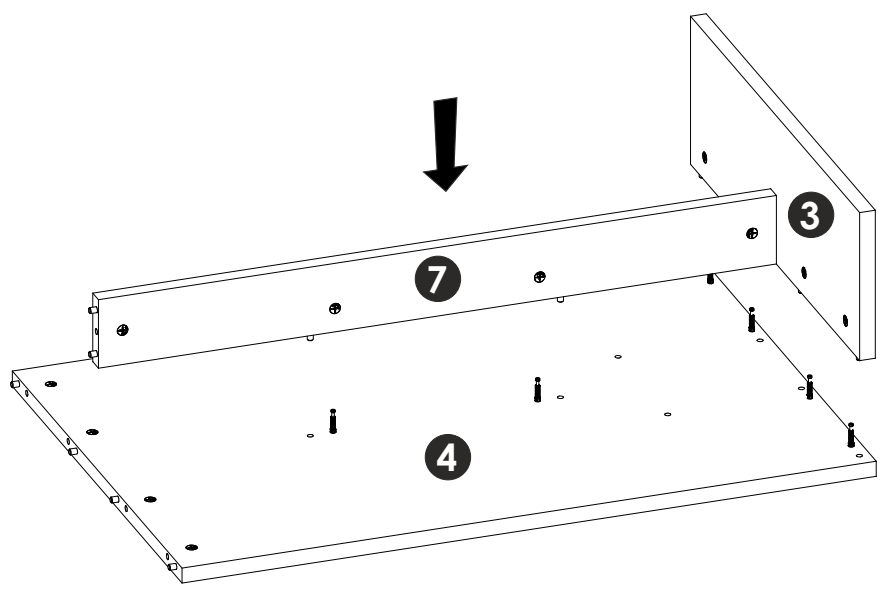
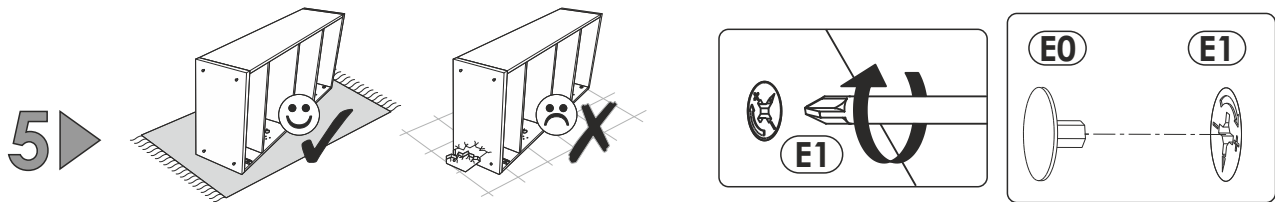

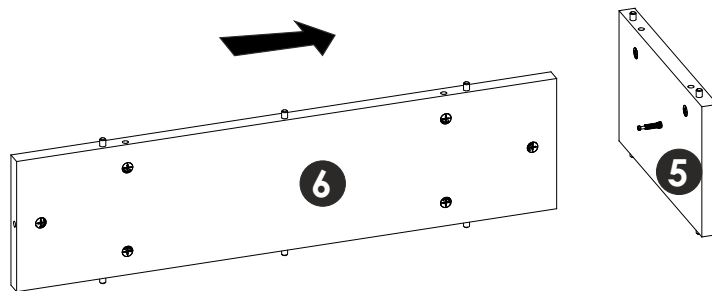
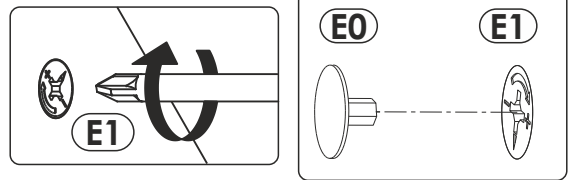
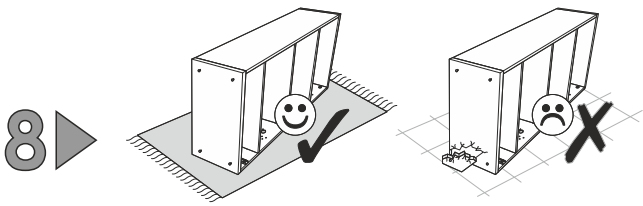
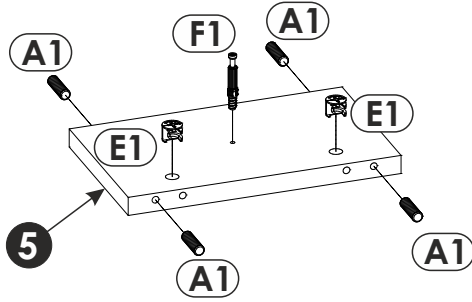
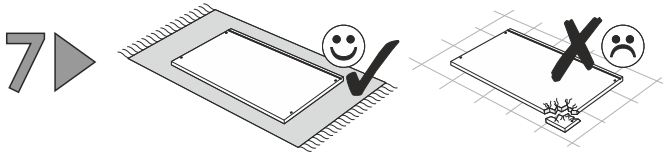

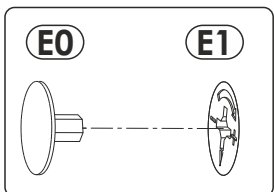
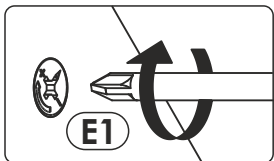
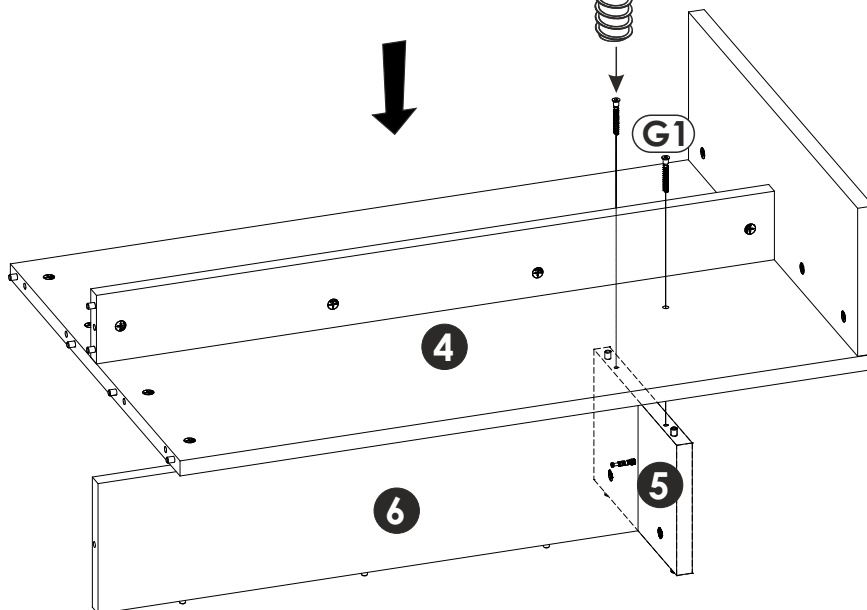
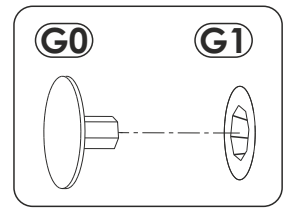
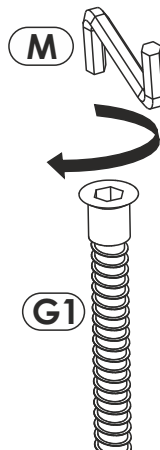
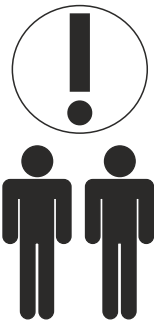
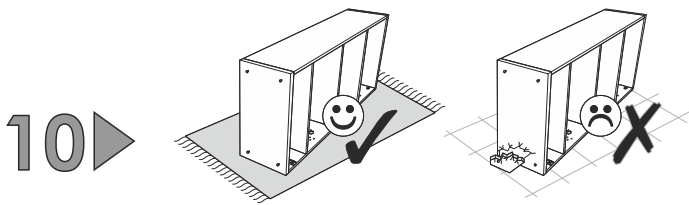
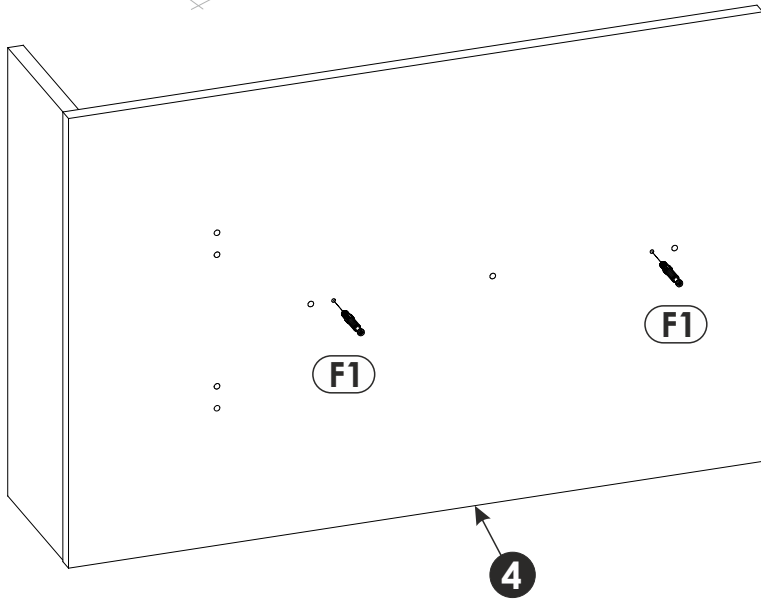
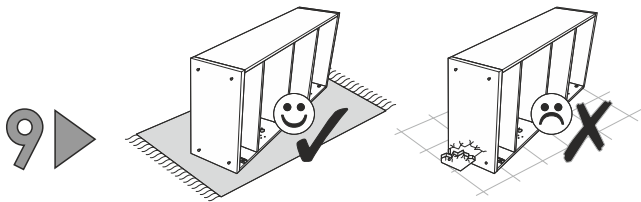

11 ▶

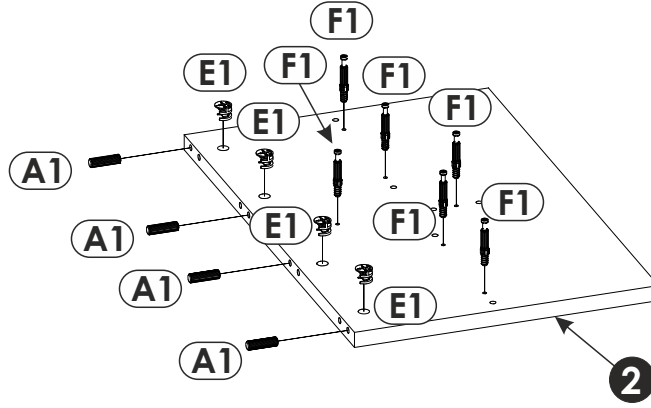
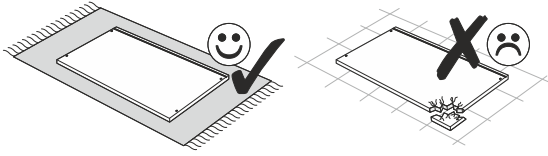

12 ▶

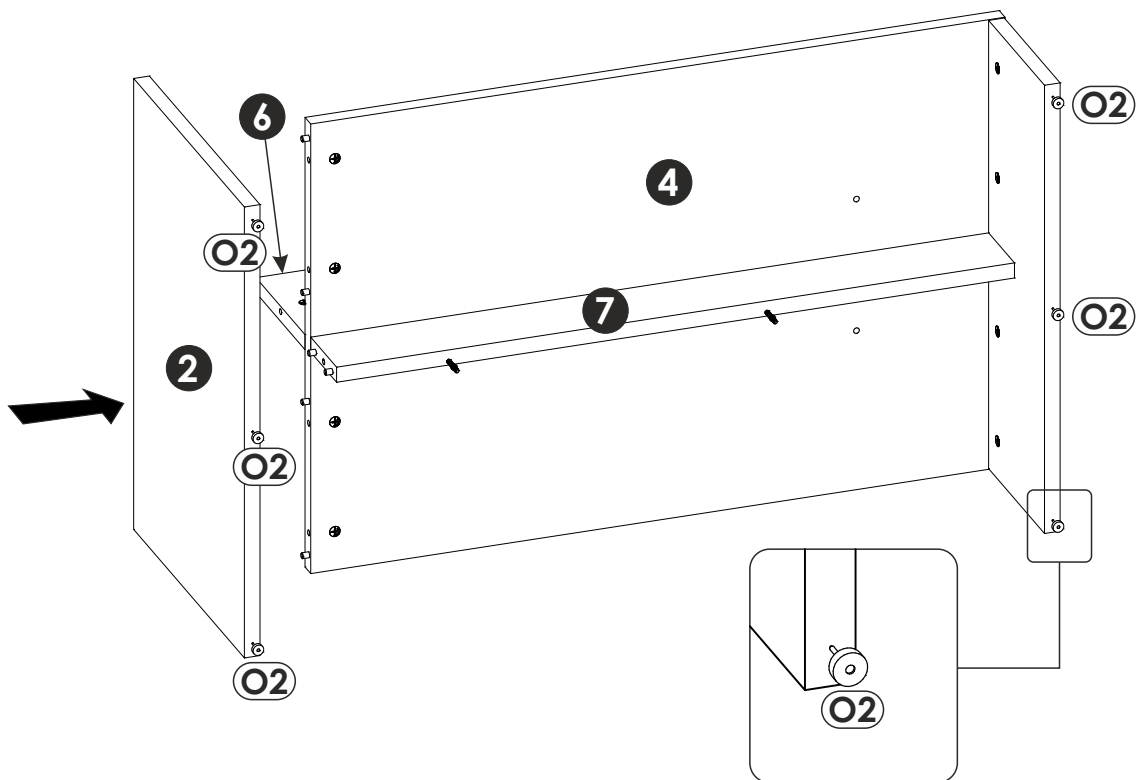
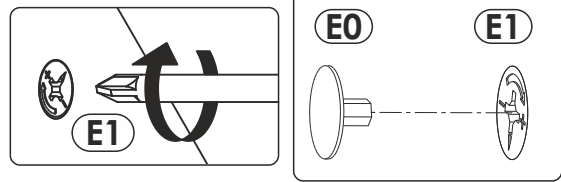
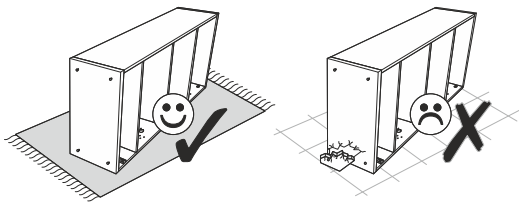

13▶

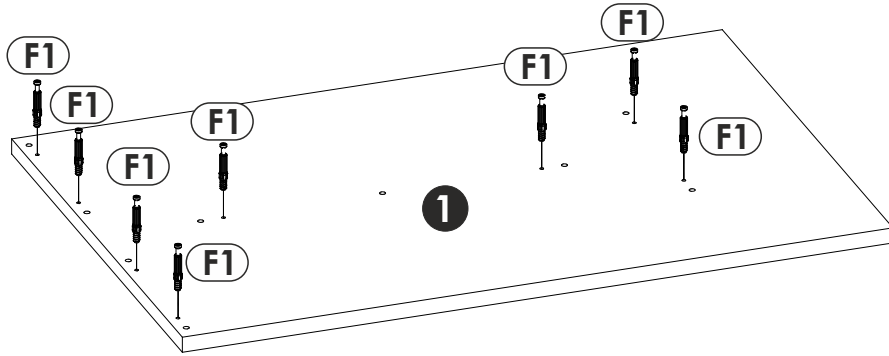
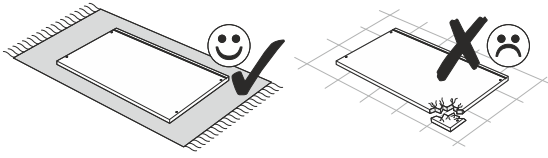

14▶

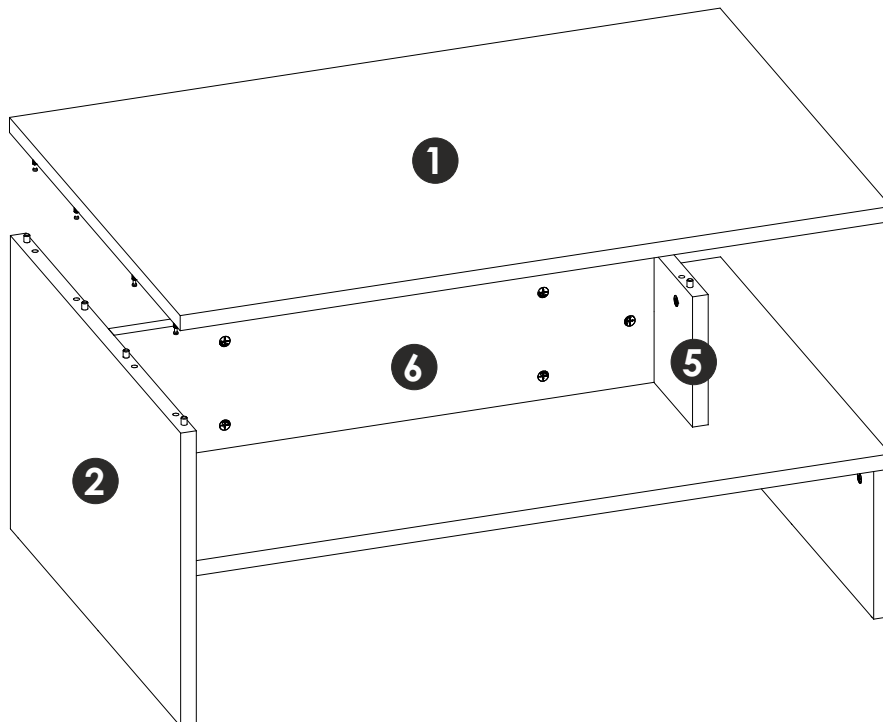
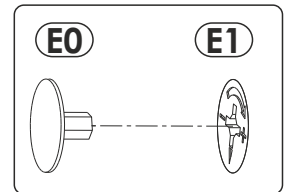
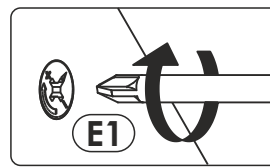
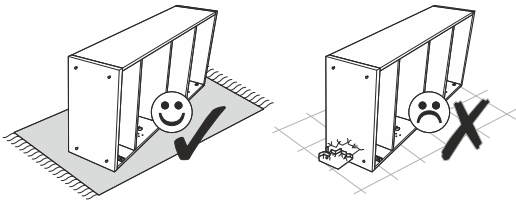

15▶

